

# Kongskilde Ploughs



OUR MAIN PLOUGH RANGE

Kongskilde ploughs

**Ploughs for all soils,  
from the experts.**

## History



# From Överum to Kongskilde

**For more than 360 years the ÖVERUM factory has led in the industrial production and processing of steel.**

For the last 165 years, they have been producing ploughs, so they know a thing or two about ploughing! The core competence, then as now, is the finishing of steel. The mould boards are made of carbonized hardened steel, so today Överum possess the most thorough processing of wearing parts on the market. The treatment time is 19 hours. Subsequently, after various intermediate steps the wearing parts are then hardened. The main plough frame is pre-treated in a similar fashion.

To ensure stress free production, this process takes place after any welding has been carried out, then the ploughs are bolted together in final assembly. Based

on this extensive experience, the XL-body has the lowest draft requirement for plough bodies on the Market. The scientific evidence studies are shown at the Swedish University in Uppsala.

Överum have paid particular attention to stone protection. Since 1968, a hydraulic stone protection has been offered. This step less system can be customized to suit all soil conditions.

Great focus is on easy and precise setting down. The sequence is as follows: horizontal, vertical, line of draft (pull) and then front furrow.

Since 2015, conventional, fully mounted, semi-mounted and wagon ploughs have been produced under the name KONGSKILDE.

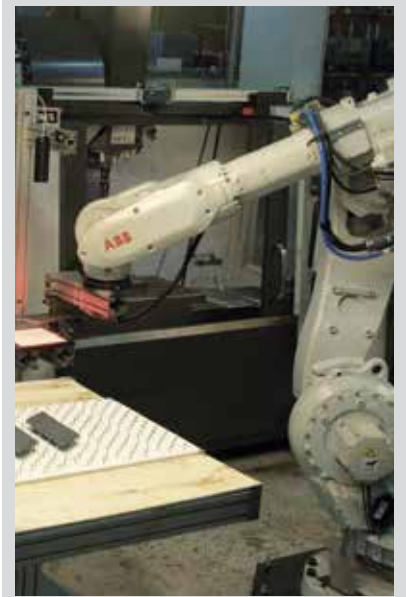



# Advantages of ploughing



## Good reasons for ploughing

**Among mechanical weed cultivation, the plough has through centuries been acknowledged to be the most reliable machines in cultivations. Threats of herbicide resistant weeds getting more and more abundant is forcing today's farmer to rearm and again upheld the plough as key strategy for weed control as last resort.**

The plough has many advantages: it not only breaks through the capillary, but mixes the crop residues and fertilizer perfectly and promotes the release of nutrients through mineralization. Harmful animals such as mice and snails are also combated to an extent by ploughing. The control of root weeds and fungal diseases is another advantage of ploughing.

This systematic procedure yields the most effective loosening around the entire region of the field.

It is also ideal to repair compaction damage. Ploughing increases the volume of the top surface by approx 30%. The proportion filled with air Pores with this method increased significantly. Surface water is also clearly absorbed faster too.

The plough bodies cut the furrow slices and then invert them. The turning action forces the soil to split up in a natural pattern. At the same time the skimmers clear the surfaces between the furrows.

**The plough requires less energy than a tine cultivator considering the cultivated volume of soil, due to the geometry of the plough body.**

**Wider furrows - 35 - 40 cm saves 11%**

**Red. depth from 24 - 19 cm saves 30%**

**The plough is an effective tool to loosen the soil, control weeds and mix crop residues and fertiliser.**

# The angle of the share does matter



The fuel consumption and the use of the tractor are highly important for farmers to achieve a low cost cultivation. The Swedish University of Agriculture (SLU) has presented interesting findings on this subject.

A comparison of the three most common plough brands was also done by SLU. A 100 hp tractor was used to measure the draft requirement of the four furrow ploughs.

The furrow width of ploughs was adjusted to 40 cm and the depth of the ploughing was 20 cm. As you can see on the diagram, the Kongskilde plough with the AX-body was the one among the competitors which had the lowest draft requirement. This result means less slippage and higher efficiency which gives a lower fuel consumption and tillage cost.

# The angle does matter

The angle of attack of the share is a vitally important feature. A Kongskilde plough does not cut or break the soil, so when correctly set the plough does not leave a pan in the bottom of the furrow unlike other makes. When correctly adjusted the leading edge of the share sits at an inclined angle compared to the landslide.

The force to pull a tine as a function of the angle of attack, after Godwin (1974)

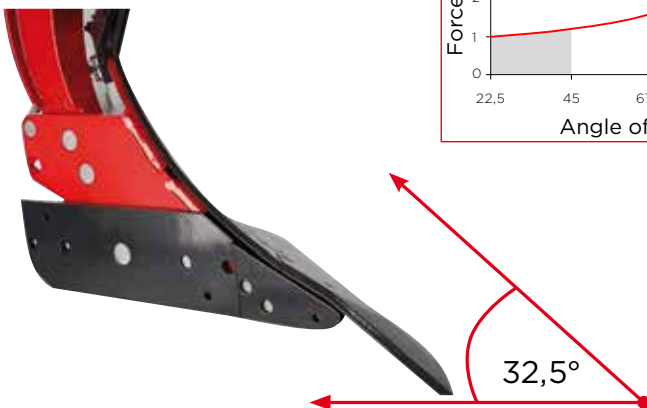
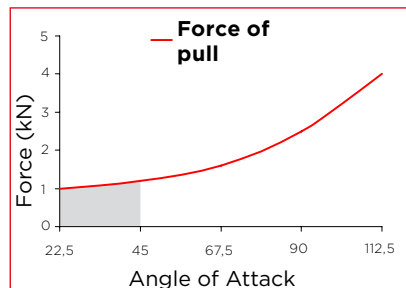

Kongskilde AX-body has the lowest draft requirement among its competitors

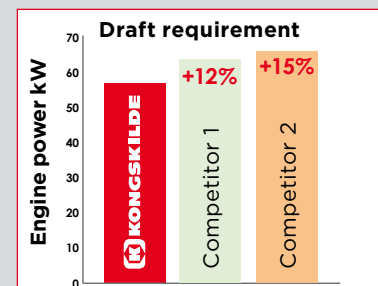

## Form follows function

---

# The design of our plough bodies



**The type AX** is a turning plough body with an extremely low draft requirement. This body has a universal application in all different types of soil for ploughing depths of 10-28 cm and with working widths of 30 - 55 cm. ▶



**The type AXP** has the same body and properties as AX, only the mould board is made of plastic. Ideal for ploughing in very sticky soils.



**The type XLD** is a turning plough body of low draft requirement, for tractors with wide tyres (710 mm). Excellent turning of the furrows plough depths of 12-30 cm with a working width of 35-60 cm. ▶



**The type AH** is a larger universal body with good crumbling and very good furrow clearance for wide tyres. For cutting widths from 40 cm and working depth to about 30 cm.



**The type AS** is a slatted body with 4 individually replaceable strips. Suitable for all soil types, is particularly impressive in sticky soil. Intensive crumbling, perfectly turned soil on a slope. For cutting widths from 40 cm and working depths below 30 cm. ▶



**Type XSD** is a new-developed turning plough body with slatted mouldboard, combining low draft requirement with very good scouring in sticky soil. The mouldboard has four separately exchangeable slats with double support stays, and has otherwise the same parts and functions as XLD.

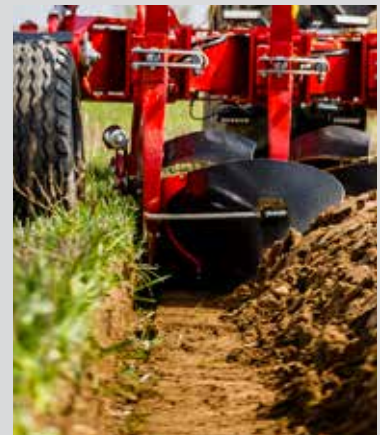
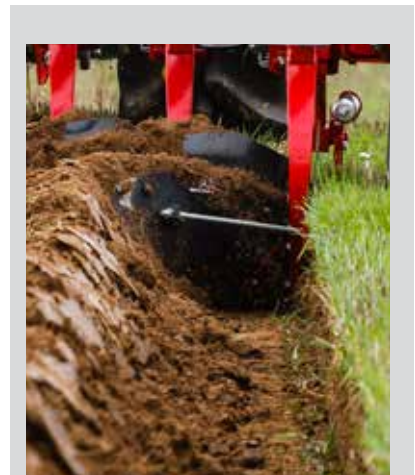

# Mucro Steel

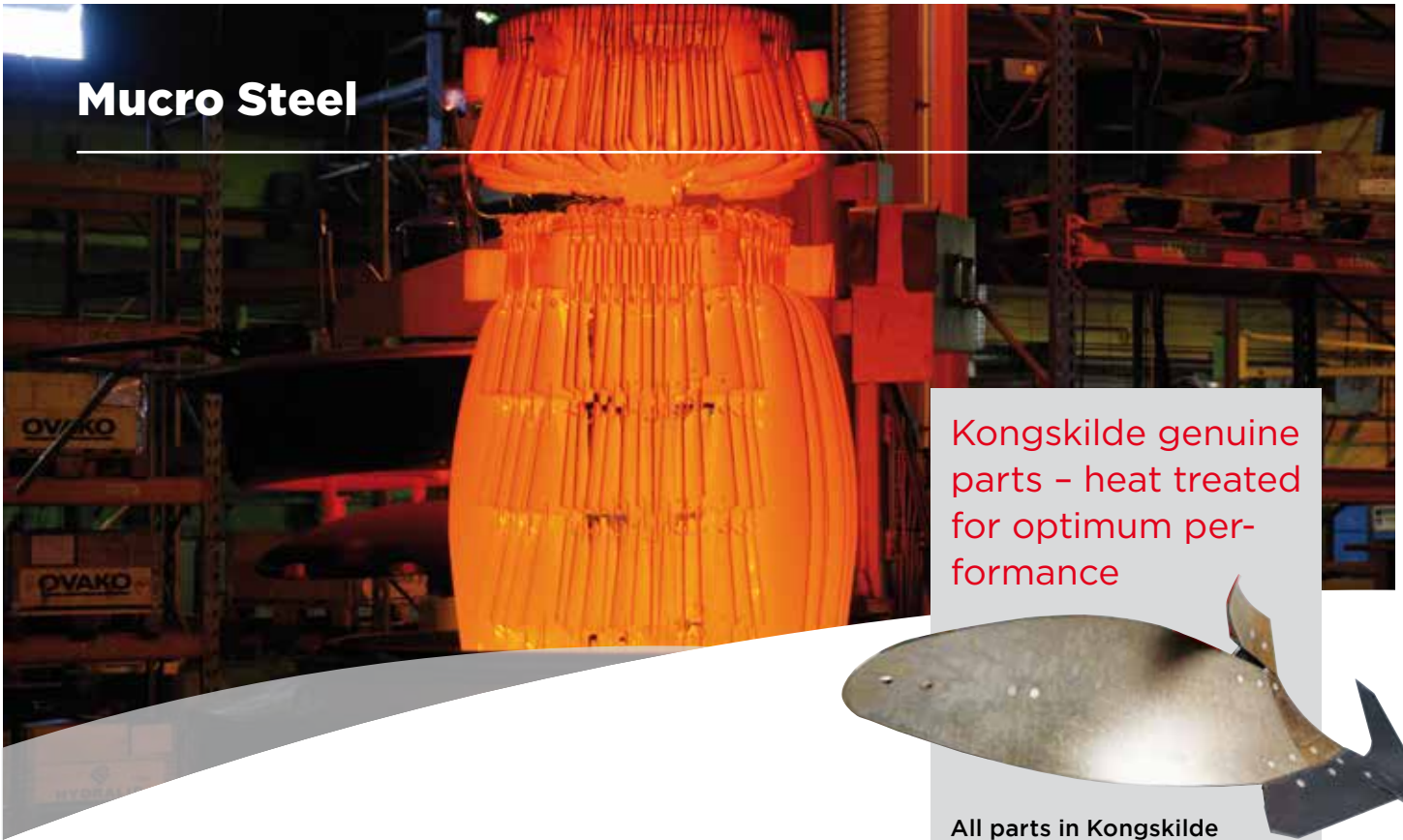

Kongskilde genuine parts - heat treated for optimum performance



## Innovative steel handling

More than 350 years of experience in steel handling is driving our benchmark for tomorrow's innovations.

### State-of-the-Art processing

The mould board blanks are processed for 18 hours in a carbon rich environment with high temperatures and cooled for 4 hours with nitrogen gas. The mouldboards are then heated up for 30 min to bring them into shape. Over 2 hours of reheating with 150° removes all stress out of the board ensuring highest quality.

### Carburizing method

The correct carbon content in the steel profile determines the perfect properties of the mouldboard. Carbon penetrates into the surface layer of the steel

creating a maximum surface hardness with a flexible inner core. Your advantage - wearing resistance as well as toughness and impact strength.

All parts in Kongskilde plough bodies have gone through different types of advanced heat treatment, in order to give the steel in each and every detail optimized characteristics for its task.

Point, share and landside are hardened for maximum wear resistance and rupture strength.

The mouldboard is given a special carburizing treatment in order to achieve even higher hardness in the surface, partly for increased wear resistance, but also for better scouring in sticky soil types.

Also the frog, on which all the wearing parts are mounted, is heat treated for best possible strength to weight ratio.



# Discover Quality

Kongskilde ploughs are designed to offer farmers quality ploughing results, easy operation and advantageous operational economy. All this is built upon several generations experiences in developing ploughs. This places Kongskilde ploughs in a league of their own. Heavy duty dimensioning and high quality material ensures a long life time!



**125 Headstock:** Means the dimension of the hollow shaft. Designed for tractors up to 180 hp. Cross shaft Cat. II and III.



**150 Headstock:** Means the dimension of the hollow shaft. For trouble free ploughing with tractors up to 220 hp. Cross shaft Cat. II and III.



**180 Headstock:** Built for heavy duty, this headstock suits perfectly the largest ploughs. Up to 360 hp. High quality 150 mm to 180 mm heat treated hollow shaft made from only 1 piece.



**Points:** The share points on Kongskilde plough bodies are extra long and designed in such a way that wear is equal throughout the lifetime. The design means good soil contact, and new points will break through an eventual ploughing pan. The long point has exceptional wearing life with homogeneous



dimension, The point, the share and the mouldboard are in the same plane on a Kongskilde body. This means that wear is distributed evenly, the power requirement is reduced, material expenditure is lower and the risk of soil sticking to the mouldboard is less than for other ploughs. Kongskilde carry

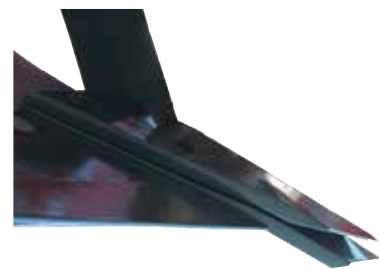

three types of points for improved performance in different systems.

**Turnable:** For improved capacity and increased lifetime. **Flush:** Improved soil flow and minimum adherence in sticky soil. **Överum Special:** Short point for rocky conditions.



# Quality for you

---

Flush or reversible points;  
wear plates for all landsides  
are available.

Heavy duty turn axle and  
removeable cross shaft is  
standard

Frame alignment cylinder  
standard from 5 furrows

Carbonized and hardened  
wearing parts

Optional hydraulic stone trip  
applying an individual accu-  
mulator for each plough leg

All frames are manufactured  
from 100 % Swedish quality  
steel

## High Tech



# Frame and Beam

Kongskilde ploughs feature frames made out of one piece, without weldings. On the frame, all parts are bolted. The design of the main frame has got precision drilling made by high technological CNC machines for the extensive bolt assembly.

Kongskilde has a high strength compared to the weight ratio! Which means that it is possible to use a heat treated Steel with 40% higher strength compared to standard frame tubes.

The profile has a high section modulus and can endure high loads. This modularity has many advantages. Worn or defective parts can be replaced easily and simple, because they are bolted. The same applies to the plough

leg. Kongskilde Plough legs are made for extrem use. Our 80 cm stone trip plough leg is made out of cast steel and is the strongest in the market.

The plough legs are not only put on top of the beam and welded, they surround the surface of the beam like an U-section.



**T-Model 80 cm: strongest plough leg of market**



**Shear Bolt: 16 mm 10.9 bolt quality, burst at a force of 4.000 kg**

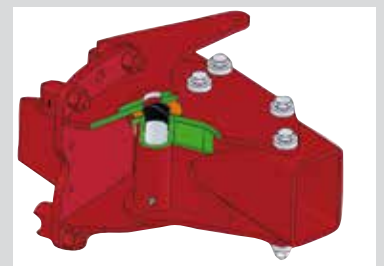

**All pivot points in the furrow width adjustment are equipped with replaceable bushes with greasing possibility. The greasing reduces the forces required and prevents dust and water getting in.**

## Easy set

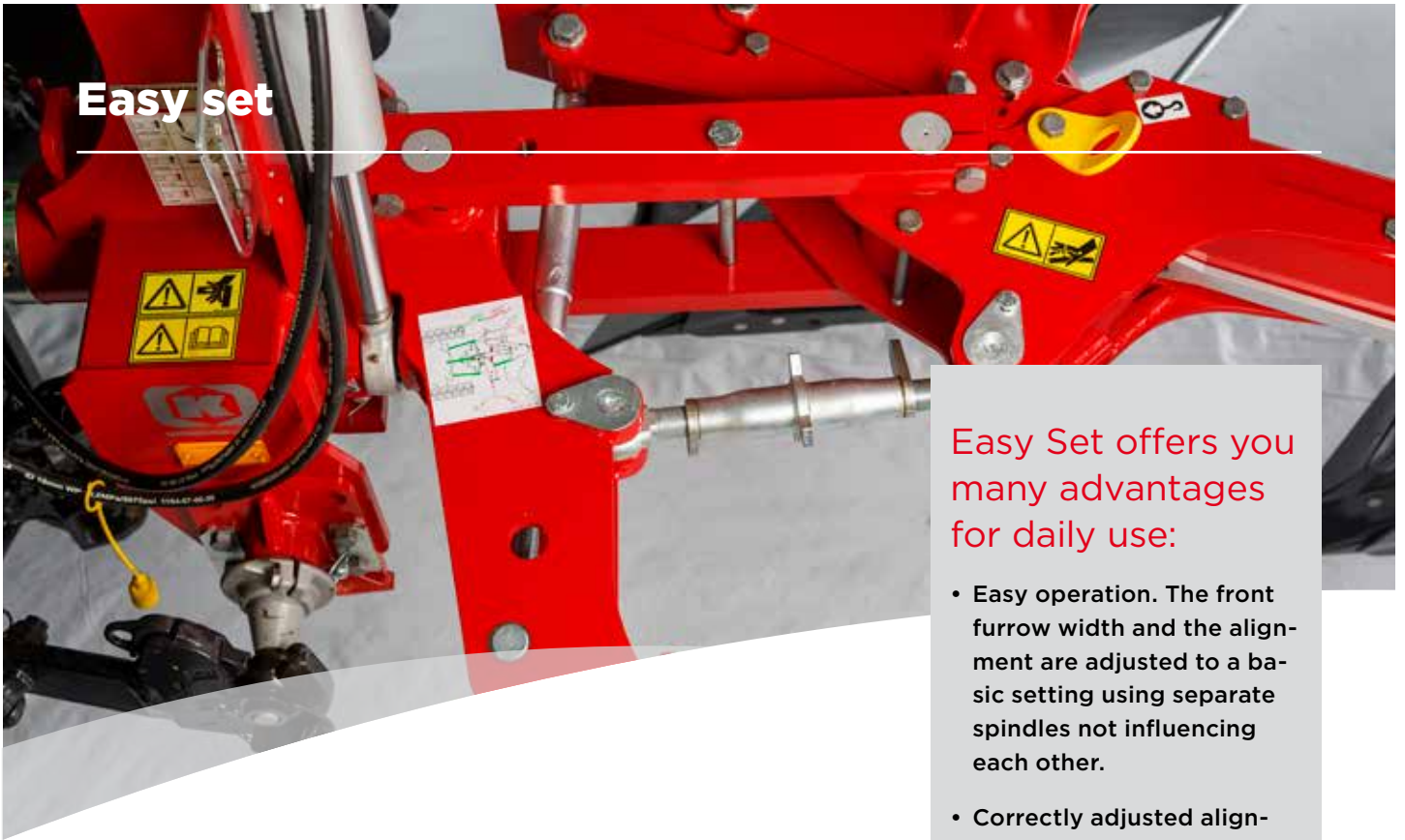

Easy Set offers you many advantages for daily use:

- Easy operation. The front furrow width and the alignment are adjusted to a basic setting using separate spindles not influencing each other.
- Correctly adjusted alignment ensures that the plough moves freely using a minimum of power.
- Manoeuvring is easy once the plough is adjusted correctly.
- On ploughs with hydraulically adjustable furrow width, Easy Set ensures perfect alignment for all furrow widths, which can be freely adjusted.
- The design is flexible, which means that shocks are not transmitted directly to the tractor.
- Correct setting minimizes use of wearing parts.
- Correct setting gives a perfect ploughing result.

# Easy Set

A simple system that ensures correct adjustment of the plough. This means excellent ploughing and lower operating costs.

Easy Set automatically adjusts the alignment of the plough as you adjust the front furrow. The system is designed as a parallelogram, where the geometry is calculated in order to adjust the alignment correctly once the basic setting of the plough is correct.

All Kongskilde fully mounted reversible ploughs have the Easy Set system as standard equipment.

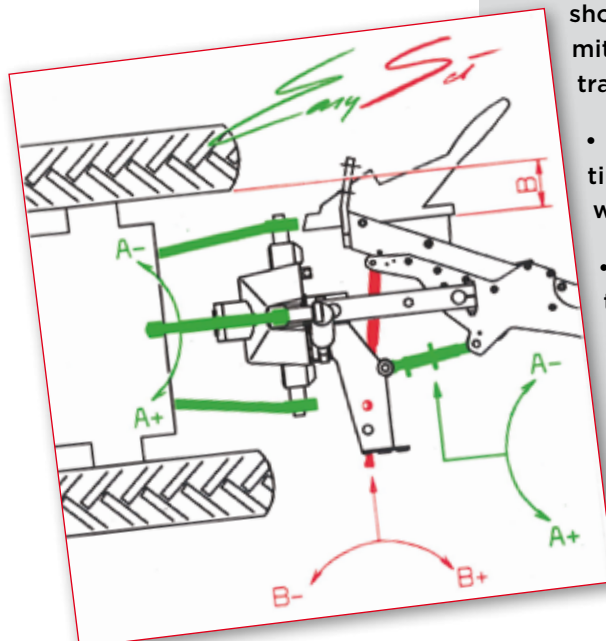

## Stone protection

# Stone release system

Kongskilde offer two kinds of stone release system; hydraulic stone release system and shear bolt system. One of the highest release heights on the market. The kinetic ensures that a minimum load of pressure is transferred to the point during release for easy passage.

### Shear bolt system

This system is most useful in soil with few fixed stones. The design is simple and inexpensive. Ploughs with shear bolts have a lower weight, and the centre of gravity is closer to the tractor. This reduces the lift requirement. The shear bolts are manufac-

tured from hard steel and dimensioned to burst at a force of 4.000 kg. All other design in the plough is dimensioned to exceed this force. With the high strength of the shear bolt you can plough non-stop even with smaller obstacles. The hard steel shears with a clean break to make it easy for you to replace bolts.

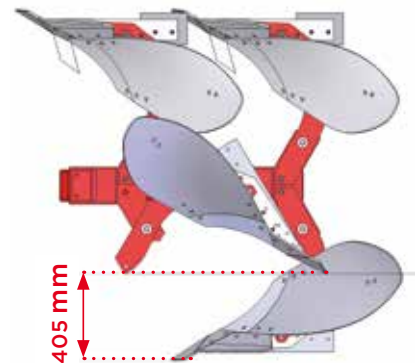

### Hydraulic stone release system

Where there are many stones in the soil, the hydraulic stone release system from Kongskilde is efficient for non-stop ploughing. The release pressure for each plough body can be adjusted individually. This means that the pressure can be set higher for the front furrow in order to keep it in the soil, without exposing the plough and the tractor to a higher load. The adjustment possibilities are wide as the resistance force may range from 950 kg to 1.500 kg for each plough body. The geometry of the release system offers a large release height to ensure non-stop ploughing even in conditions with large stones and for deep ploughing.

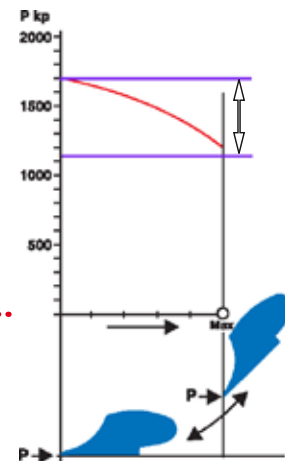
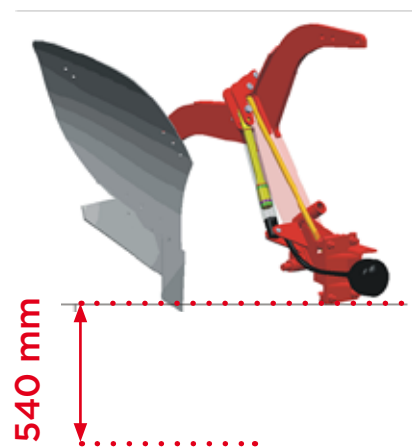

*One of the highest release heights on the market. The kinetic ensures that a minimum load of pressure is transferred to the point during release for easy passage*

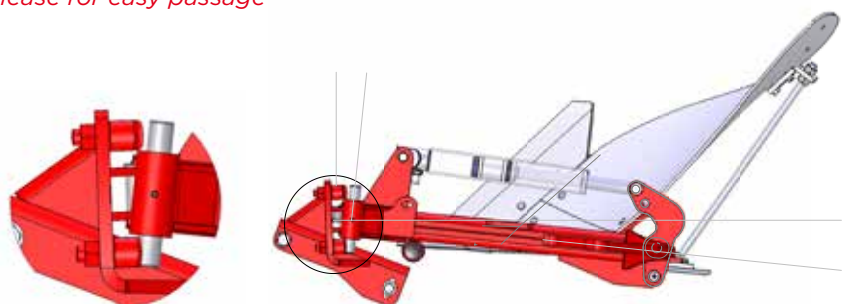

# Stone protection

---



A Perfect Plough for everybody

---

# Our Plough Range





**RS**  
**RT**

# The perfect match for light tractors

RT/S is a plough range aimed for the smaller farmers and suitable for tractors up to 100 kW. The range consists of fully mounted reversible ploughs with low lift requirement. The centre of gravity is close to the tractor for minimum lift requirement. The RT/S ploughs “turn under” which means that the bodies pass under the frame and the depth wheel passes up high when the plough is turned. RT is equipped with a

fully automatic hydraulic stone release system and RS with fixed beams with individual shear bolts for each leg.

The furrow width can easily be adjusted in four steps to suit different ploughing conditions. In comparison to the weight the ploughs have a strong design manufactured from high grade heat-treated steel in vital parts means durable strength.



## Technical Specifications

| max tractor | Ø      | □            | X | ↑↓    | ←→          | ↑         | ←→                        | ↑↓ min tractor |
|-------------|--------|--------------|---|-------|-------------|-----------|---------------------------|----------------|
| <b>RS</b>   |        |              |   |       |             |           |                           |                |
| 140         | 125 mm | 150 x 100 mm | 3 | 75 cm | 90 / 100 cm | S: 405 mm | 12" - 14" - 16" - 18"/20" | 1500           |
| 140         |        |              | 4 |       |             |           |                           | 1900           |
| <b>RT</b>   |        |              |   |       |             |           |                           |                |
| 140         | 125 mm | 150 x 100 mm | 3 | 75 cm | 90 cm       | T: 540 mm | 12" - 14" - 16" - 18"     | 2100           |
| 140         |        |              | 4 |       |             |           |                           | 2500           |

S = Stonerelase and T = Stonetrip

# MRS MRT



## THE standard plough







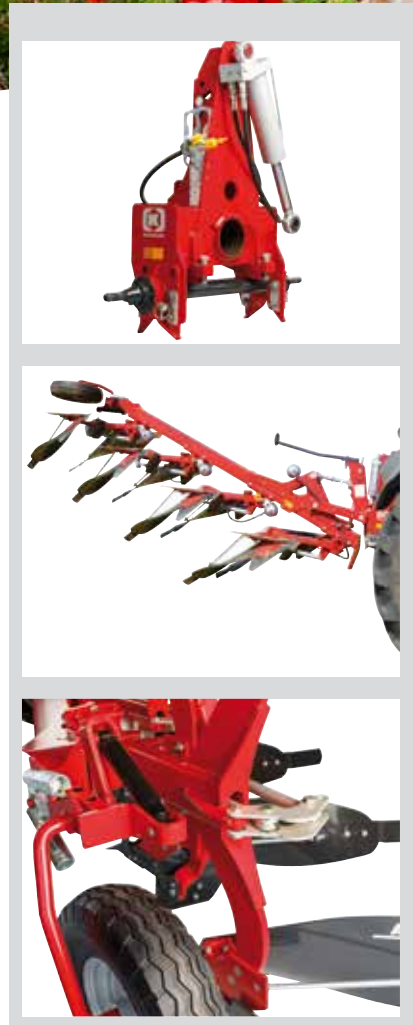

MRT/S represents the medium class models of Kongskilde Ploughs for tractors up to 130 kW. These reversible fully mounted ploughs feature a modular designed beam support and draw frame allowing all the stress to be evenly distributed over the full length of the plough.

The result is a simple strong and clean design with logical and easy adjustment. The Kongskilde

MRS/T ploughs are manufactured from high quality steel for strength and reliability to work in the toughest conditions. This gives a plough for modern farmers who focus on professional farming, functional equipment and economical operation. The big pivot shaft diameter spreads the load on a large surface while the plough is turning over. The direction of turnover can be chosen. The frame is extendable.



### Technical Specifications

|  |  |  |  |  |  |  |  |  |
|---|---|---|---|---|---|---|---|---|
| <b>MRS</b>  |   |   |   |   |   |   |   |   |
| 180   | 125 mm  | 150 x 150 x 8 mm  | 3   | 75 / 80 cm  | 90 / 100 cm   | S: 405 mm   | 90 cm:<br>14" - 16" - 18"   | 1700  |
| 180   |   |   | 4   |   |   |   |   | 2500  |
| 180   |   |   | 5   |   |   |   |   | 3300  |
| <b>MRT</b>  |   |   |   |   |   |   |   |   |
| 180   | 125 mm  | 150 x 150 x 8 mm  | 3   | 75 / 80 cm  | 90 / 100 cm   | T: 540 mm   | 100 cm:<br>16" - 18" - 20"  | 2500  |
| 180   |   |   | 4   |   |   |   |   | 3400  |

S = Stonerelease and T = Stonetrip



# MRWS MRWT



## Staying flexible

MRWT/S are reversible fully mounted plough with hydraulic operated working width. MRWT/S has a well thought out construction where the furrow width can be controlled from 30 to 50 cm. The pivot point for the furrow width adjustment is placed in the pulling line of the plough beam. This minimizes the adjustment forces and the wear of the bearings. All pivot points in the furrow width adjustment are also equipped with re-

placeable bushes with greasing possibility. The greasing reduces the forces required, and prevents dust and water getting in.

Kongsilde MRWT/S has a high strength compared to the weight ratio! The direction of turnover or turnunder can be chosen according to the conditions. During the turn process, while the frame is aglinmet, the working width is not reduced.



### Technical Specifications

| max         |        | Ø            | ▧ | X          | ↕           | ↔         | ↑           | ↔ | ↑ | min  |
|-------------|--------|--------------|---|------------|-------------|-----------|-------------|---|---|------|
| <b>MRWS</b> |        |              |   |            |             |           |             |   |   |      |
| 180         |        |              |   | 3          |             |           |             |   |   | 1600 |
| 180         | 125 mm | 100 x 150 mm | 4 | 75 / 80 cm | 90 / 100 cm | S: 405 mm | 12" tot 20" |   |   | 2600 |
| 180         |        |              | 5 |            |             |           |             |   |   | 3500 |
| <b>MRWT</b> |        |              |   |            |             |           |             |   |   |      |
| 180         |        |              | 3 | 75 / 80 cm | 90 / 100 cm | T: 540 mm | 12" tot 20" |   |   | 3000 |
| 180         | 125 mm | 100 x 150 mm | 4 |            |             |           |             |   |   | 4000 |

S = Stonerelase and T = Stonetrip

**HRS  
HRT**

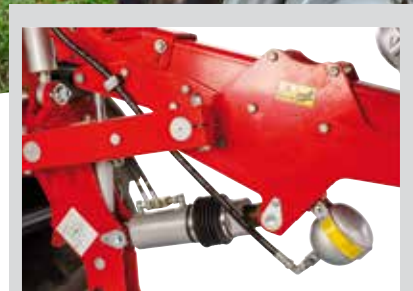

# The work horse

The Kongskilde HRS/T -series consists of fully mounted reversible ploughs intended for Tractors up to 165 kW and heavy duty ploughing. Modern clean design and quality manufacture are the main characteristics for the Kongskilde HRS/T ploughs.

width as the forces increase forward in the plough. The HRT/S wheel is placed at the rear of the plough for the best weight transfer. The frame is extendable.

The frame of the HRS/T is a sturdy U-profile and the frame is built to a wedge form with increasing

## Technical Specifications

| <b>HRS</b> |        |                  |   |            |             |           |             |      |
|------------|--------|------------------|---|------------|-------------|-----------|-------------|------|
| 220        | 150 mm | 150 x 150 x 9 mm | 4 | 75 / 80 cm | 90 / 100 cm | S: 405 mm | 90 cm:      | 3000 |
| 220        |        |                  | 5 |            | 90 cm       |           | 14"-16"-18" | 4000 |
| 220        |        |                  | 6 |            | 16"-18"-20" |           | 5000        |      |
| <b>HRT</b> |        |                  |   |            |             |           |             |      |
| 220        | 150 mm | 150 x 150 x 9 mm | 4 | 75 / 80 cm | 90 / 100 cm | T: 540 mm | 90 cm:      | 4000 |
| 220        |        |                  | 5 |            |             |           | 16"-18"-20" | 5000 |

S = Stonerelase and T = Stonetrip

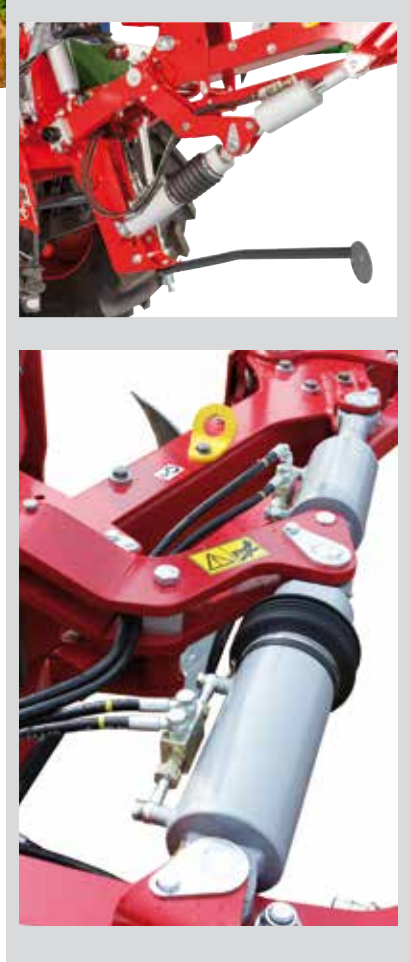

# The smart all-rounder

HRWT/S is the plough model from Kongskilde for tractors up to 165 kW. The plough range is equipped with a heavy duty headstock with a 150 mm pivot shaft and needle bearings. The five furrow models are equipped with an alignment cylinder as a standard. The working width is hydraulically adjustable within a range of 30 to 50 cm. The favorable geometry in the regulation

system makes it possible to adjust the working width on the go with relatively low pressure. All pivot points in the furrow width adjustment are equipped with replaceable bushes with greasing facilities, for less friction and for keeping the dirt and water out. During the turn process, while the frame is alignmet, the working width is not reduced

## Technical Specifications

| <b>HRWS</b> |        |              |   |            |             |           |             |      |
|-------------|--------|--------------|---|------------|-------------|-----------|-------------|------|
| 220         | 150 mm | 150 x 100 mm | 4 | 75 / 80 cm | 90 / 100 cm | S: 405 mm | 12" tot 20" | 3500 |
| 220         |        |              | 5 |            |             |           |             | 4500 |
| <b>HRWT</b> |        |              |   |            |             |           |             |      |
| 220         | 150 mm | 150 x 100 mm | 4 | 75 / 80 cm | 90 / 100 cm | T: 540 mm | 12" tot 20" | 4000 |
| 220         |        |              | 5 |            |             |           |             | 5000 |

S = Stonerelease and T = Stonetrip

**XRS  
XRT**



# Heavy Duty for high performance

The XRS/T series has a simple and clean construction, with few moving parts. XRS/T is suitable for tractors up to 250. The working width can be manually adjusted in 5 steps. XRS/T is equipped with a quick coupling cross shaft that can be placed in four different positions. The head stock can be equipped with cat. 3 or 4 cross shaft. The pivot shaft with needle bearings is 180mm and spreads the forces

on a very big surface when turning the plough. A hydraulic alignment ram automatically straightens the plough behind the tractor to give it a gentle turning action. After the turn the plough automatically returns to working position. This system minimizes the strain of the tractor.

XRS/T frames are extendable.

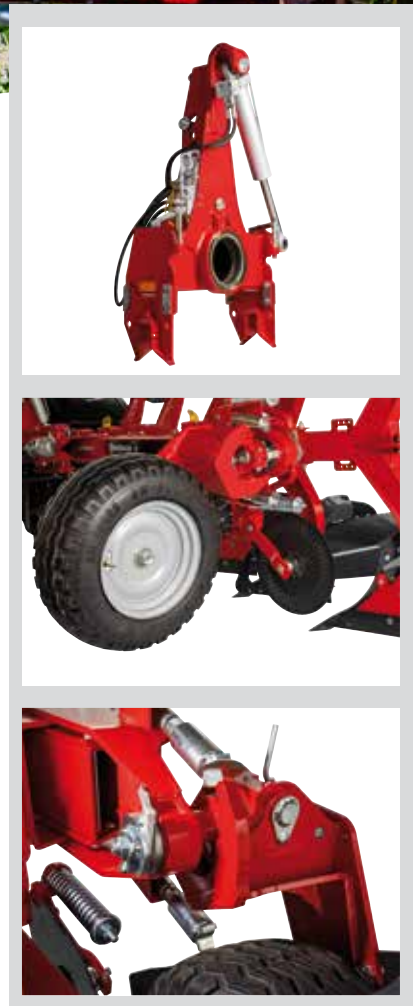

## Technical Specifications

| <b>XRS</b> |              |              |   |            |             |           |                             |      |
|------------|--------------|--------------|---|------------|-------------|-----------|-----------------------------|------|
| 360        | 150 - 180 mm | 120 x 220 mm | 4 | 75 / 80 cm | 90 / 100 cm | S: 405 mm | 14" - 16" - 18" - 20" - 22" | 5000 |
| 360        |              |              | 5 |            | 90 cm       |           |                             | 6000 |
| 360        |              |              | 6 |            |             |           |                             | 7000 |
| <b>XRT</b> |              |              |   |            |             |           |                             |      |
| 360        | 150 - 180 mm | 120 x 220 mm | 4 | 75 / 80 cm | 90 / 100 cm | T: 540 mm | 14" - 16" - 18" - 20" - 22" | 5000 |
| 360        |              |              | 5 |            |             |           |                             | 6500 |
| 360        |              |              | 6 |            | 90 cm       |           |                             | 8000 |

S = Stonerelease and T = Stonetrip



**XRWS  
XRWT**

# The benchmark for professionals

Reversible fully mounted plough with hydraulic operated working width. The geometrical design of the furrow width setting results in easy adjustment on the go with limited pressure needed. All pivot points are equipped with replaceable bushings with greasing possibility. The headstock is like XRS/T made really strong with a 180 mm pivot axle placed in needle bearings for an efficient distribution of load. The plough range is equipped

with a double cylinder. One half of the cylinder manages the automatic alignment. The other half of the double cylinder is controlling the furrow width adjustment.

When the turnover is activated the furrow width is automatically going down to min. position, the plough reverses, and the furrow width comes back to the pre set value again. XRWS/T frames are extendable.



## Technical Specifications

| <b>XRWS</b> |              |              |   |            |             |           |            |      |
|-------------|--------------|--------------|---|------------|-------------|-----------|------------|------|
| 360         | 150 - 180 mm | 120 x 220 mm | 4 | 75 / 80 cm | 90 / 100 cm | S: 405 mm | 14" to 22" | 4500 |
| 360         |              |              | 5 |            | 90 cm       |           |            | 5500 |
| 360         |              |              | 6 |            |             |           |            | 6800 |
| <b>XRWT</b> |              |              |   |            |             |           |            |      |
| 360         | 150 - 180 mm | 120 x 220 mm | 4 | 75 / 80 cm | 90 / 100 cm | T: 540 mm | 14" to 22" | 5000 |
| 360         |              |              | 5 |            |             |           |            | 6500 |
| 360         |              |              | 6 |            | 90 cm       |           |            | 8000 |

S = Stonerelease and T = Stonetrip

# XRWT on land



## Comfortable and Flexible







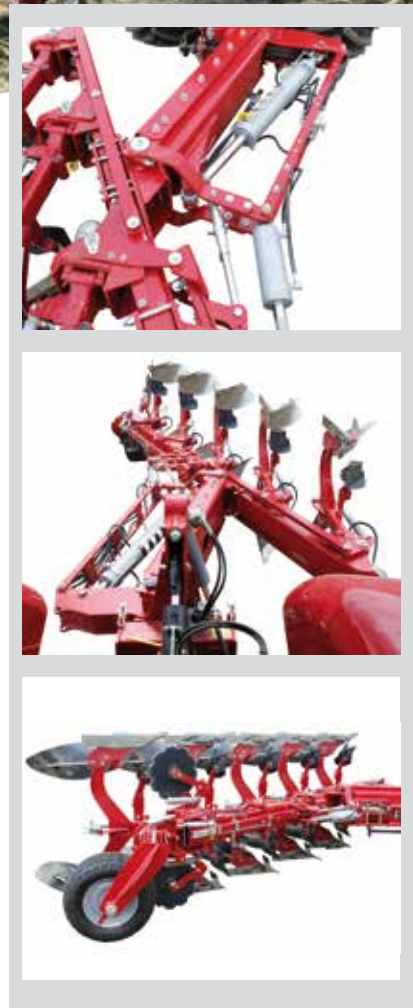

Kongsilde XRWT On Land is a new series of heavy duty fully mounted reversible ploughs. The On-land feature means that the plough can be pulled by a tracked or wheeled tractor with dual wheels on un-ploughed land with accurate GPS support. In on-land position the plough is in balance for turn-over without any alignment movement. This makes the turnover quick and easy. At XRWT On-land only two locker

need to be shift, to change front furrow to On-land position.

In-furrow position automatic alignment to minimum working width takes place before turn-over of the plough. When the furrow width is changed, the plough is automatically adjusting the front furrow accordingly. Transport in the butterfly position reduces heavy shocks both for the tractor and for the plough.



### Technical Specifications

|  max |  |  |  |  |  |  |  |  min |
|---|---|---|---|---|---|---|---|---|
| XRWT on Land  |   |   |   |   |   |   |   |   |
| 360   | 150 - 180 mm  | 120 x 220 mm  | 5   | 75 / 80 cm  | 90 cm   | T: 540 mm   | 14" tot 22 "  | 6500  |
| 360   |   |   | 6   |   |   |   |   | 8500  |
| 360   |   |   | 7   |   |   |   |   | 11000   |

S = Stonerelase and T = Stonetrip

# FMRT

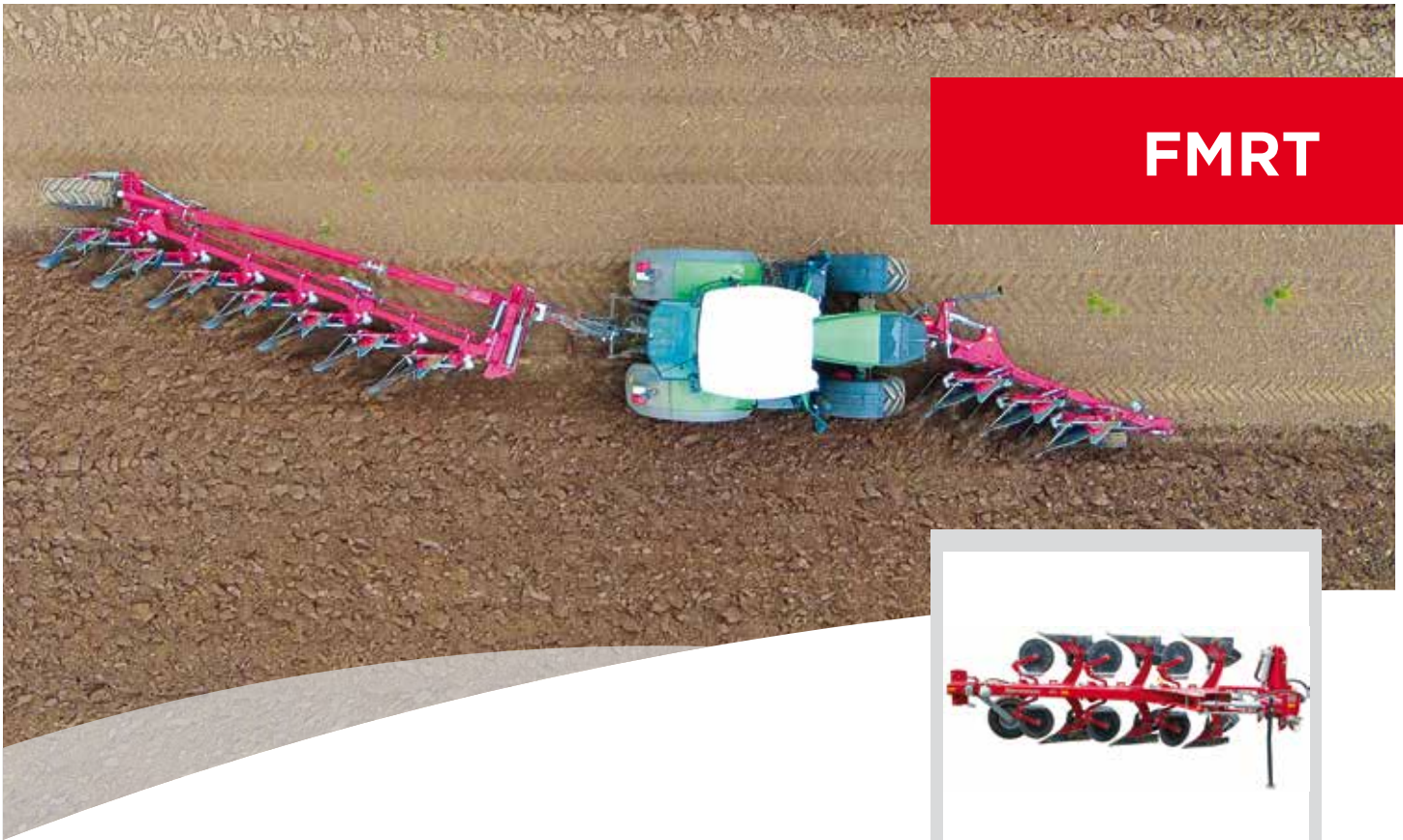

## Front is possible too

Fully mounted reversible plough "Non Stop" hydraulic.

Kongskilde FMRT front mounted reversible plough gives greater opportunities to use increasingly common tractor front linkages. The series consists of two and three furrow FMRT -ploughs with hydraulic stone release system.

By using the Kongskilde FMRT in combination with a normal rear

mounted reversible plough, better weight distribution is achieved compared to operating a fully mounted 7- or 8-furrow plough rear mounted.

### Technical Specifications

| FMRT |        |              |   |       |        |           |                 |      |
|------|--------|--------------|---|-------|--------|-----------|-----------------|------|
| 360  | 125 mm | 150 x 150 mm | 2 | 75 cm | 100 cm | T: 540 mm | 16" - 18" - 20" | 2500 |
| 360  |        |              | 3 |       |        |           |                 | 3000 |

S = Stonerelase and T = Stonetrip

# SRT HSRT

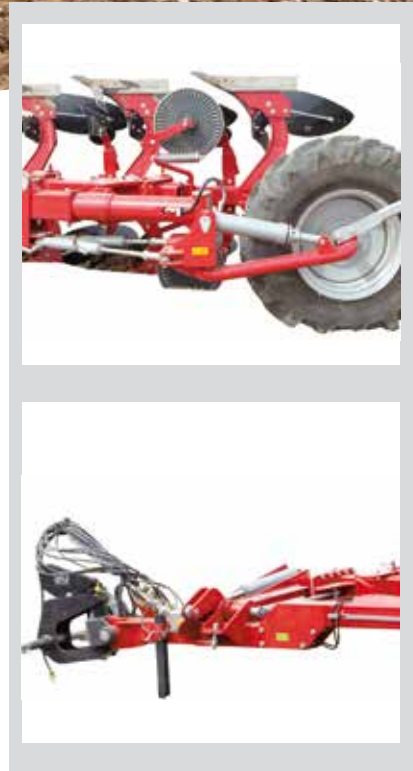







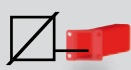

## For high capacity ploughing

SRS/T 4-7 furrow, HSRS/T from 5-8 furrows. Fixed beam shear bolt version or hydraulic stone trip. Both models have robust frames with high ground clearance. A large area of free space around the tractor treaded depth wheel

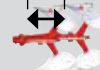
means trouble free ploughing under difficult conditions. Narrow transport width, a low centre of gravity and good weight distribution enable quick and safe transport without compromising steering ability on rough surfaces.

### Technical Specifications

|  |  |  |  |  |  |  |  |  |
|---|---|---|---|---|---|---|---|---|
| <b>SRS</b>  |   |   |   |   |   |   |   |   |
| 225   | A: 150 x 150 x 9 mm   | B: 150 x 150 x 9 mm   | 5   | 75 cm   | 90 cm   | S: 405 mm   | 14" - 16" - 18"   |   |
| 225   |   |   | 6   |   |   |   |   |   |
| <b>SRT</b>  |   |   |   |   |   |   |   |   |
| 225   | A: 150 x 150 x 9 mm   | B: 150 x 150 x 9 mm   | 5   | 75 cm   | 90 cm   | T: 540 mm   | 14" - 16" - 18"   |   |
| 225   |   |   | 6   |   |   |   |   |   |
| <b>HSRS</b>   |   |   |   |   |   |   |   |   |
| 360   | A: 250 x 150 x 8 mm   | B: 180 x 180 x 10 mm  | 6   | 80 cm   | 100 cm  | S: 405 mm   | 14" - 16" - 18"   |   |
| 360   |   |   | 7   |   |   |   |   |   |
| 360   |   |   | 8   |   |   |   |   |   |
| <b>HSRT</b>   |   |   |   |   |   |   |   |   |
| 360   | A: 250 x 150 x 8 mm   | B: 180 x 180 x 10 mm  | 6   | 80 cm   | 100 cm  | T: 540 mm   | 14" - 16" - 18"   |   |
| 360   |   |   | 7   |   |   |   |   |   |
| 360   |   |   | 8   |   |   |   |   |   |

S = Stonerelease and T = Stonetrip and A = Main frame and B = Draw frame



# HSRWT



## The proud flag ship







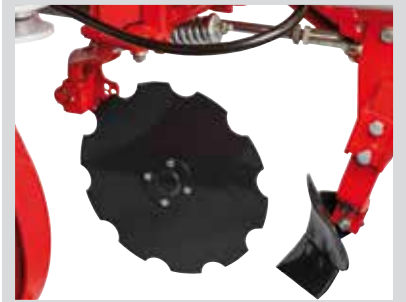

The Kongskilde HSRWS/T plough incorporates the heavy-duty beam housing design already introduced on the Semi mounted plough with hydraulically adjustable furrow width. Fixed beam shear bolt version or with hydraulic stone trip. Both models have robust frames with high ground clearance. A large area of free space around the tractor treaded depth wheel means trouble free ploughing

under difficult conditions. Narrow transport width, a low centre of gravity and good weight distribution enable quick and safe transport without compromising steering ability on rough surfaces.

One of the largest wheel dimensions available on the market (420/70 R 25) ensures low pull resistance during work and high stability during road transport.

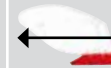

### Technical Specifications

|              |  |  |  |  |  |  |  |  |  |
|--------------|---|---|---|---|---|---|---|---|---|
| <b>HSRWS</b> |   |   |   |   |   |   |   |   |   |
| 360          | A: 120 x 220 x 10 mm  | B: 180 x 180 x 10 mm  | 7   | 80 cm   | 100 cm  | S: 405 mm   | 14'' to 22''  |   |   |
| 360          |   |   | 8   |   |   |   |   |   |   |
| <b>HSRWT</b> |   |   |   |   |   |   |   |   |   |
| 360          | A: 120 x 220 x 10 mm  | B: 180 x 180 x 10 mm  | 6   | 80 cm   | 100 cm  | T: 540 mm   | 14'' to 22''  |   |   |
| 360          |   |   | 7   |   |   |   |   |   |   |
| 360          |   |   | 8   |   |   |   |   |   |   |

S = Stonerelase and T = Stonetrip

# Options

## Skimmers



**EG / EP Skimmers**

The mouldboard are protected with Shear bolts against obstacles. In addition to the Length also the side grip can be adjusted at Kongskilde skimmers.

EC skimmers: wide, flat cut. For normal conditions

EP skimmers: plastic Moldboard. Ideal for sticky, boggy soils.



**EM Skimmers**

Ideal for larger amounts of Crop residues , e.g. Corn. The mouldboard are protected with Shear bolts against obstacles. In addition to the Length also the side grip can be adjusted at Kongskilde skimmers.



**Coverboard**

Good passing of straw, mixes good Plant remains in. Good for different conditions less suitable for sticky soils.

## Accessories



**Rippled Disc**



**Notched Disc**



**Plain Disc**

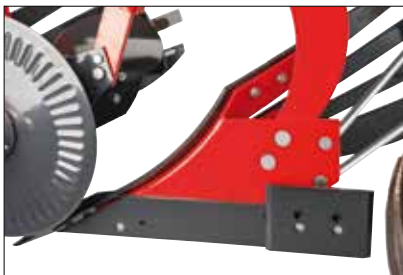

**Landside wearing plate**



**Standard furrow knife**



**Offset furrow knife**

# Options

## Wheels medium range



**Steel - ø 500x160 mm**

RS/RT · MRS/MRT



**Rubber - ø 7.00-12**

MRS/MRT · HRS/HRT



**Double center wheel - 23x8.50-12**

RS/RT · MRS/MRT - center mounted



**Rubber/Combi - ø 10.0/80-12/8**

MRS/MRT · HRS/HRT  
MRWS/MRWT · HRWS/HRWT



**Rubber/Combi - ø 10.5/65-16/10**

HRS/HRT - rear or center mounted

## Wheels heavy range



**Maximum traction wheel - 26x12.00-12**

MRS/MRT · HRS/HRT · MRWS/MRWT · HRWS/HRWT - mechanical depth adjustment, hydraulic brake. Here equipped with rim sides.



**Rubber/Combi - 260/70-16**  
**Rubber/Combi HD - 340/55-16**

XRS/XRT · XRWS/XRWT · XRWT  
On Land - mechanical depth adjustment, mechanical friction brake.



**New centre mounted combi wheel**

for XRS/XRT - XRWS/XRWT - XRWT On Land.  
Choice of mechanical or hydraulic depth adjustment, hydraulic brake.



**Hydraulic depth control**  
for tractor treaded support wheel.



**Hydraulic depth control**  
and tractor treaded tire for combi wheel above.



Subject to modifications. 101002596 EXP/GB/Kongskilde ploughs/BRO/0319

**Kongskilde Agriculture**

Tel. +45 61 80 50 00

[office@kongskilde.com](mailto:office@kongskilde.com)

[www.kongskilde.com](http://www.kongskilde.com)

**K KONGSKILDE**  
Moving agriculture ahead